

USE RECLOSER ACCESSORIES TO FIT YOUR APPLICATION

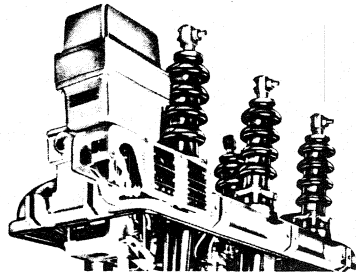

CURRENT METERING



SHUNT-CLOSING

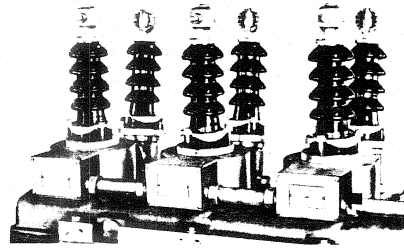

BUSHING CURRENT TRANSFORMERS

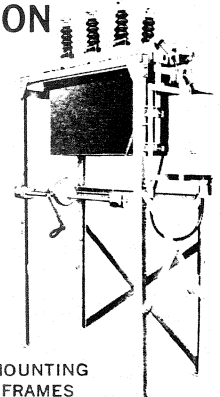

MOUNTING FRAMES

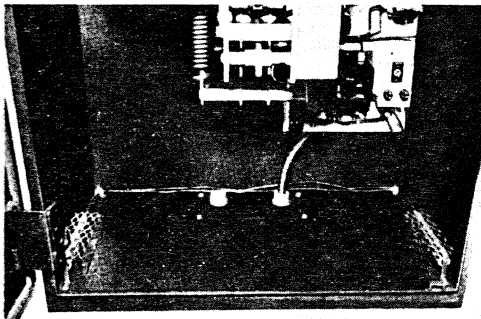

CABINET HEATER

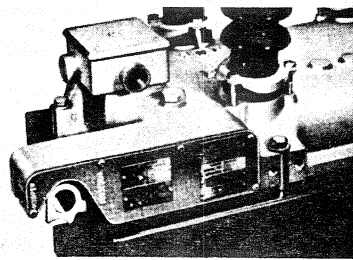

JUNCTION BOX

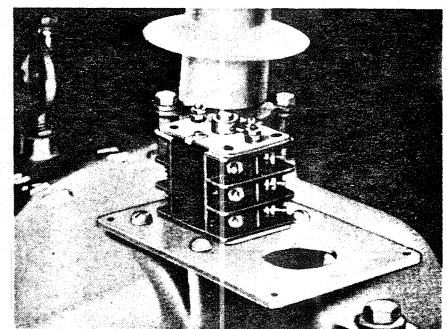

AUXILIARY SWITCH

TABLE OF CONTENTS

	Page		Page
<b>Applications</b> .....	2	21. Remote operating mechanism .....	14
<b>Types R and W recloser series accessories</b>		22. Ground-trip shorting switch .....	15
1. Type TR current transformer .....	2	23. Oil level sight gauge .....	15
2. Bushing-type current transformer .....	3	24. Factory assembly .....	15
3. Ground-trip solenoid mechanism .....	4	25. Conduit and wiring kits .....	16
4. Shunt-trip solenoid mechanism .....	6	<b>Types CXE, CVE Reclosers</b>	
5. Shunt-closing solenoid mechanism .....	7	1. Cabinet heater .....	17
6. Dual reclosing time mechanism .....	7	2. Bushing current transformers .....	17
7. Shunt-lockout solenoid mechanism .....	8	3. Tank valves .....	17
8. Shunt blocking mechanism .....	8	4. Visual oil gauge .....	17
9. Auxiliary switch .....	9	5. Metering accessory kit .....	17
10. Low-voltage dc closing coil .....	9	<b>Type VSA Accessories</b>	
11. Dc closing with an ac source .....	9	1. Bushing current transformers .....	17
12. Stud-type terminals .....	10	2. Auxiliary switch .....	18
13. Flat pad terminals .....	10	3. Metering accessory kits .....	18
14. Creepage distance bushings .....	11	<b>Types ME, MLE, MVE Accessories</b>	
15. Junction box and terminal blocks .....	11	1. Cabinet heater .....	18
16. Emergency manual closing tool .....	11	2. Bushing current transformers .....	18
17. Mounting frames .....	12		
18. Tank valve .....	13		
19. Current metering .....	13		
20. Lockout indicating switch .....	14		



## SINGLE-PHASE RECLOSERS

### Types H, 4H, L, D, E

Accessories for these single-phase reclosers are normally factory-installed and must be ordered as part of the single-phase recloser catalog number. Refer to Section 280-10 for mounting hangers and accessories.

## THREE-PHASE RECLOSERS

### Types 3H, 6H

Accessories for the Types 3H and 6H reclosers are normally factory-installed and must be ordered as part of the recloser catalog number. Refer to Section 280-10 for mounting frames and accessories.

### Types R, RV, W, WV

Oil circuit reclosers provide accurate and dependable circuit protection as self-contained devices. With various combinations of accessories, the reclosers can satisfy a wide range of additional application requirements. Several over-current protection schemes can now be achieved more economically by employing low-cost hydraulic reclosers in place of conventional circuit breakers. Accessories can be factory-installed on new reclosers, or they can be added to reclosers in service.

Several accessories require the assistance of one or more additional accessories to carry out a particular scheme. Be sure to order the proper wiring kit for each application by consulting the price list.

*The following accessories require the addition of a KA187R junction box and terminal block to the recloser:* GROUND-TRIP SOLENOID MECHANISM, SHUNT-TRIP SOLENOID MECHANISM, SHUNT-CLOSING SOLENOID MECHANISM, SHUNT-LOCKOUT SOLENOID MECHANISM, SHUNT-BLOCK MECHANISM, AND LOW VOLTAGE CLOSING.

*The following accessories require no additional accessories:* DUAL RECLOSING TIME MECHANISM, AUXILIARY SWITCH, TANK VALVE, AND LOCKOUT-INDICATING SWITCH.

*When current metering is installed on the KA584R1 mounting frame, KA584R4 brackets are required to mount the metering accessories on the frame.*

*Metering and ground-trip applications are the two most predominate schemes that require the use of either the TR transformer or bushing current transformers. The TR transformer cannot be used with the Type RV or WV recloser.*

## Types RE, RVE, WE, WVE

These electronically controlled reclosers satisfy a wide variety of application requirements and they can be easily adjusted to meet new conditions.

In addition to the accessories listed in this bulletin that are available to simplify mounting and connecting these reclosers, a number of accessories with further application possibilities can be used with the recloser's electronic control. Because the Type ME electronic control is used with other reclosers, the control accessories are listed and described in Section 280-65.

## 1. TYPE TR THREE-PHASE CURRENT TRANSFORMERS FOR TYPES R AND W ONLY

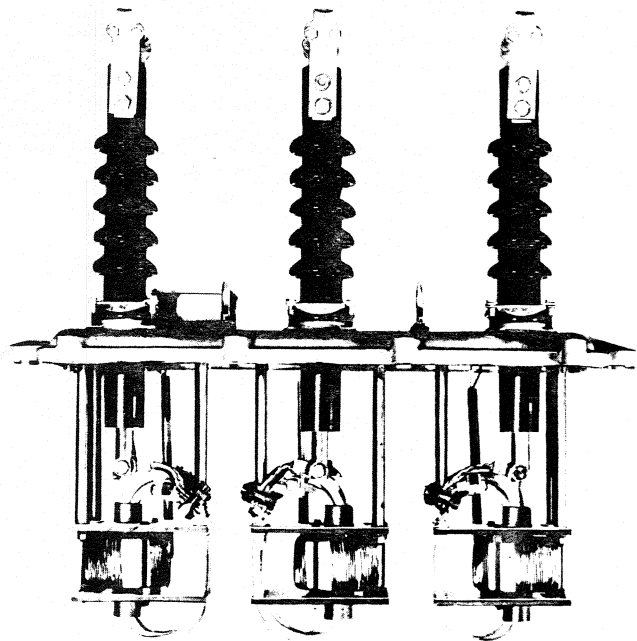

Untanked 280-ampere transformer.

### DESCRIPTION

A TR current transformer, mounted on a Type R or W recloser mounting frame, provides for ground-fault relaying, current metering, or both. Each unit consists of three current transformers mounted in an oil-filled tank. Primaries terminate on cover bushings; secondaries terminate in an external weatherproof box.

Ground-fault sensing is achieved by connecting a ground-trip solenoid in series with paralleled TR secondaries. Zero-sequence or residual current will flow in a grounded phase. This current can be employed to trip the recloser by means of the ground-trip solenoid.

The standard 280-ampere transformer has four primary taps that are changed easily in the field. Type TR transformers rated 280 amperes can be used with Type W reclosers in locations where the maximum available symmetrical fault current does not exceed 8000 amperes.

### SPECIFICATIONS

#### INSULATION, KV

BIL . . . . .	110
Maximum design voltage . . . . .	15.5

#### WEIGHT, POUNDS

Complete . . . . .	340
Less oil . . . . .	230

#### SIZE, OVER-ALL

Width . . . . .	11 3/4
Length . . . . .	36
Height . . . . .	32 3/4

Secondary terminal box has threaded 1-inch IPS hub for conduit or cable connector.

USA Metering Accuracy Class	Burden
0.6	.1
0.6	.2
1.2	.5

### ORDERING INFORMATION

When ordering, specify catalog number KTR280A\* for an adjustable, 280-ampere transformer.

\*Add number of primary turns required. See ground-trip solenoid table on page 5. For example, 100-ampere minimum ground-fault current tripping can be provided with a four-turn, 280-ampere transformer. Current catalog number would be KTR280A4.

### 2. BUSHING CURRENT TRANSFORMERS Types R, RE, RV, RVE, W, WE, WV, WVE

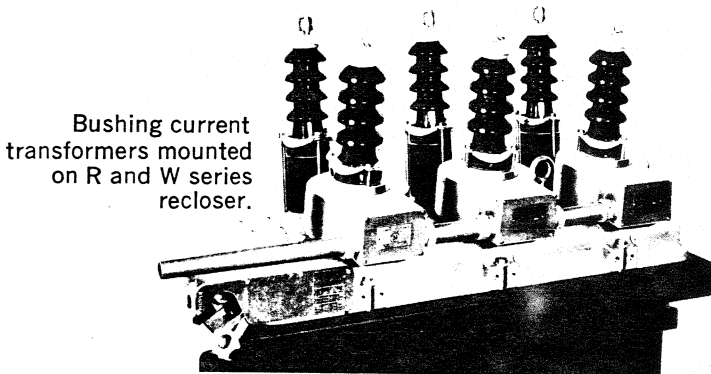

### DESCRIPTION

Bushing current transformers are mounted externally on the head casting of the recloser and provide a convenient means of current metering.

Ratio	Relay Accuracy Class	Metering Accuracy Class		
		.3B-0.5	.6B-1.0	1.2B-2.0
600:5	2.5L100	.3B-0.5	.6B-1.0	1.2B-2.0
500:5	10L100	.3B-0.5	.6B-1.0	1.2B-2.0
400:5	2.5L50	.3B-0.2	.6B-0.5	1.2B-2.0
300:5	10L50	.3B-0.2	.6B-0.5	1.2B-1.0
200:5	—	—	.6B-0.2	1.2B-0.5
100:5	—	—	—	—

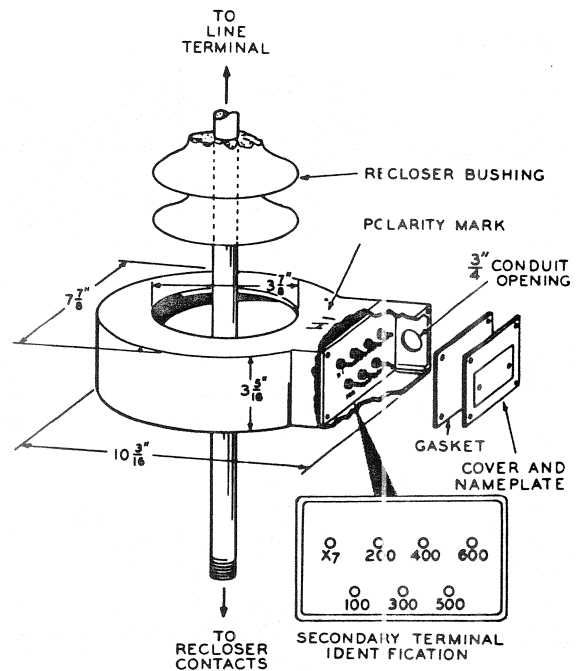

Bushing current transformer.

### ORDERING INFORMATION

When ordering, specify catalog numbers as shown below:

1. Factory-installed, external, bushing-type current transformers

Number of Transformers	Types R and W Catalog Numbers			
	R & RE		W & WE	
	11 5/8" Std.	17" Creepage	11 5/8" Std.	17" Creepage
2*	KA844R2X	KA637R2X	KA804W2X	KA110W2X
3*	KA844R3X	KA637R3X	KA804W3X	KA110W3X
6†	KA844R6X	KA637R6X	KA804W6X	KA110W6X

X stands for transformation ratio which should be specified as follows when factory wiring of current transformer is required. 1=100:5; 2=200:5; 3=300:5; 4=400:5; 5=500:5; 6=600:5.

\* Current transformers are mounted on LOA) side bushings, unless SOURCE side bushings are specified.

† One transformer is mounted on each bushing. Factory installation includes conduit between the current transformers and conduit fittings.



Number of Transformers	Types RV and WV Catalog Numbers			
	RV & RVE		WV & WVE	
	17" Standard	26½" Crp.	17" Standard	26½" Crp.
2*	KA19RV2X	KA21RV2X	KA12WV2X	KA14WV2X
3*	KA19RV3X	KA21RV3X	KA12WV3X	KA14WV3X
6†	KA19RV6X	KA21RV6X	KA12WV6X	KA14WV6X

X stands for transformation ratio which should be specified as follows when factory wiring of current transformers is required. 1=100:5; 2=200:5; 3=300:5; 4=400:5; 5=500:5; 6=600:5.

\* Current transformers are mounted on LOAD side bushings, unless SOURCE side bushings are specified.

† One transformer is mounted on each bushing. Factory installation includes conduit between the current transformers and conduit fittings.

2. Kit for field installation of external, bushing-type current transformers

Number of Transformers	Types R and W Catalog Numbers			
	R* & RE		W & WE	
	11½" Std	17" Creepage	11½" Std.	17" Creepage
2	KA845R2	KA851R2	KA806R2	KA828R2
3	KA845R3	KA851R3	KA806R3	KA828R3
6	KA845R6	KA851R6	KA806R6	KA828R6

Number of Transformers	Types RV and WV Catalog Numbers			
	RV & RVE		WV & WVE	
	17" Standard	26½" Crp.	17" Standard	26½" Crp.
2	KA800RV2	KA802RV2	KA800WV2	KA801WV2
3	KA800RV3	KA802RV3	KA800WV3	KA801WV3
6	KA800RV6	KA802RV6	KA800WV6	KA801WV6

\* Above serial number 37:2.

Field installation kit includes mounting hardware and replacement bushings for the recloser, plus conduit between the current transformers and conduit fittings.

### 3. GROUND-TRIP SOLENOID MECHANISM

#### Types R, RV, W, WV

#### DESCRIPTION

A ground-trip solenoid, mounted inside the recloser and connected to paralleled current transformer secondaries, senses ground-fault currents and causes the recloser to trip. This device enables the recloser to protect against ground-fault currents that are less than the recloser's minimum-trip setting. For ground-fault currents above the recloser's minimum-trip setting, opening is governed by the series-trip solenoids or the ground-trip solenoid, depending on which is faster. Ground-trip solenoid characteristics can be teamed with series-trip solenoid characteristics to provide sensitivity to high-impedance (low-current) ground faults and low-impedance (high-current) phase faults.

Two solenoids are available. A KA510R solenoid can operate on curves shown on page 5. This solenoid can also provide dual timing consisting of one or more operations on either curve 1-3 or 1-2, followed by operations on curve

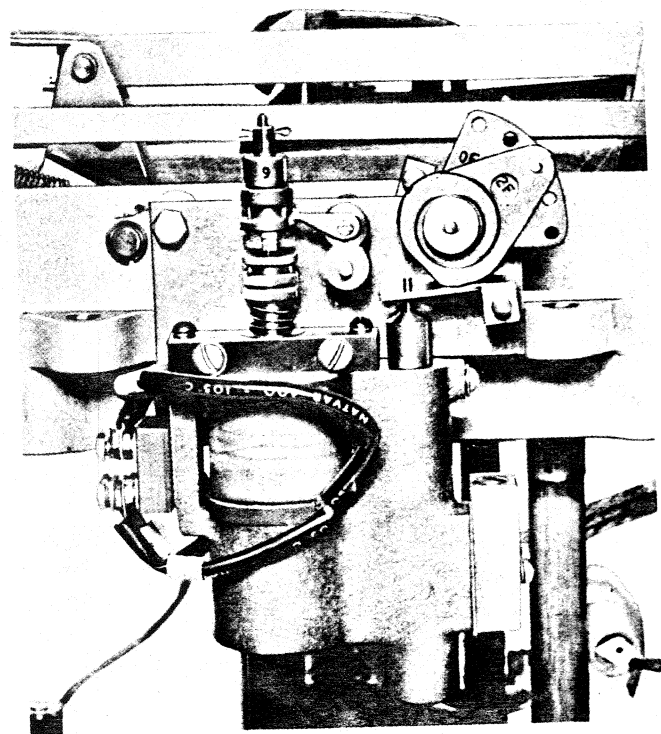

Ground-trip solenoid mounted in recloser.

2 or 3. The KA419R solenoid operates similarly except fast inverse-time tripping occurs along a modified curve. Lockout of the recloser occurs in one, two, three, or four operations, depending upon its setting. This is true for operations caused by the series-trip solenoids or the ground-trip solenoid.

Definite-time curves 5, 7, 8, and 9 are also available with the ground-trip solenoid. A ground-trip solenoid can be changed from inverse- to definite-time operation or vice versa. However, these changes are not recommended unless facilities are available for recalibrating the solenoid. Therefore, the desired curves should be determined before ordering the recloser so calibration can be performed at the factory.

#### SPECIFICATIONS

Minimum zero-sequence trip currents for KA510R or KA419R ground-trip solenoid and bushing-type current transformer combinations are:

Transformation Ratio	Coil Connections	
	Series	Parallel
100:5	63.5	110
200:5	110	205
300:5	154	300
400:5	205	403
500:5	247	500
600:5	300	596



Minimum zero-sequence trip currents for KA510R or KA-419R ground-trip solenoid and TR current transformer combinations are:

Ground-Trip Coil Connection		Current Transformers		Minimum Operating Current Primary Amperes
Series	Parallel	Primary Turns	Ratio	280-Amp TR
X		4	100:5	50
X		3	133:5	67
	X	4	100:5	100
X	X	2	200:5	100
	X	3	133:5	133
	X	2	200:5	200
X		1	400:5	200
	X	1	400:5	400

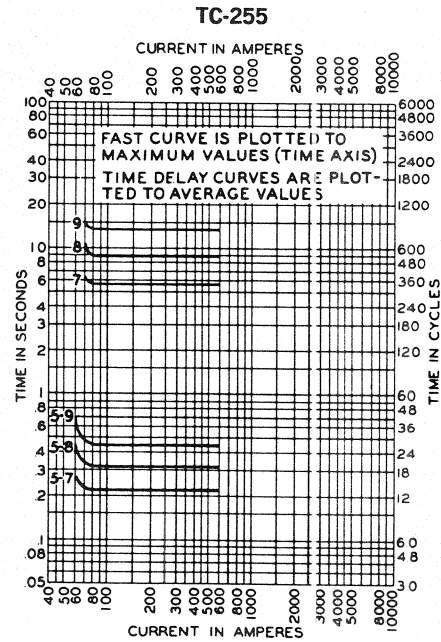

Definite ground-trip TCC's with KA510R solenoids.

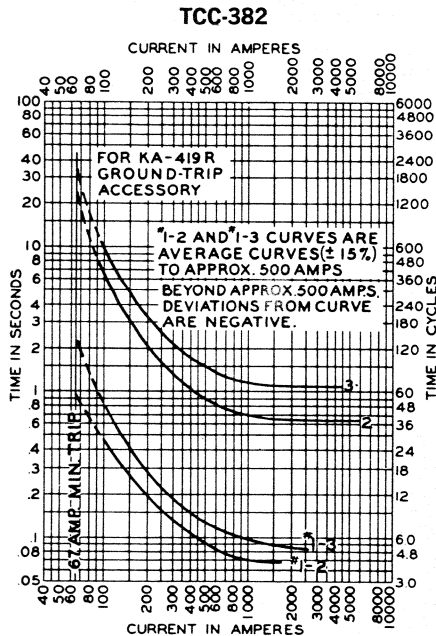

Modified ground trip solenoid KA419R to obtain special curve.

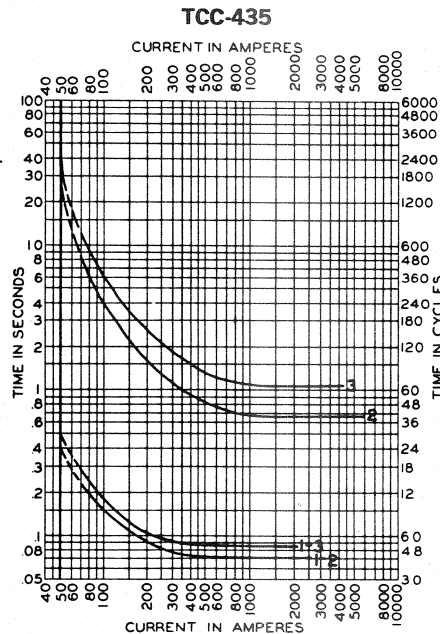

Coil connections are in series. Curves apply to all ratios of Type TR current transformers and can be indexed to other minimum-trip settings of 67, 100, or 200 amperes.

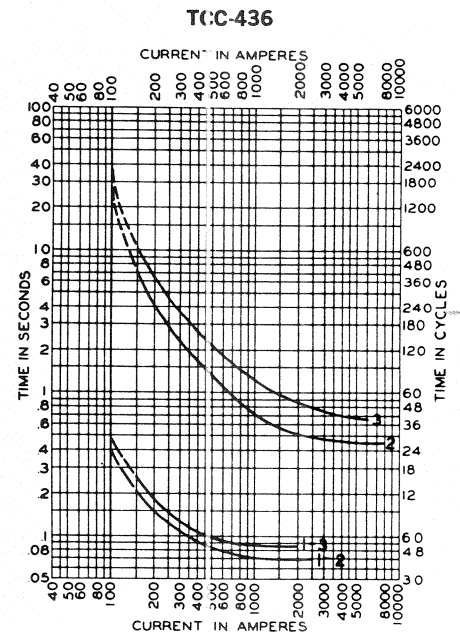

Coil connections are in parallel. Curves apply to all ratios of Type TR current transformers and can be indexed to other minimum-trip settings of 133, 200, and 400 amperes.



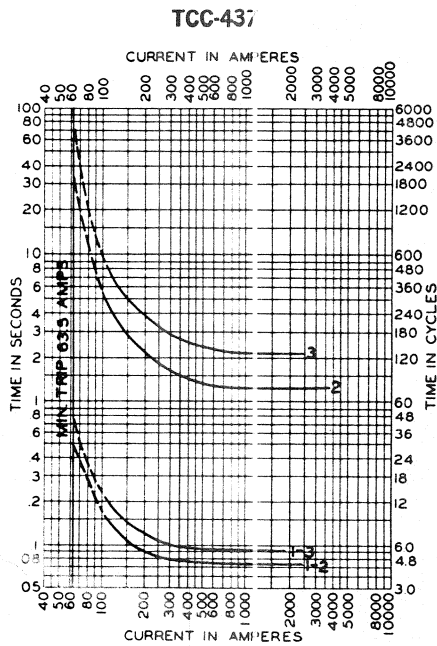

Coil connections are in series. Curves apply to bushing CT ratio of 100:5.

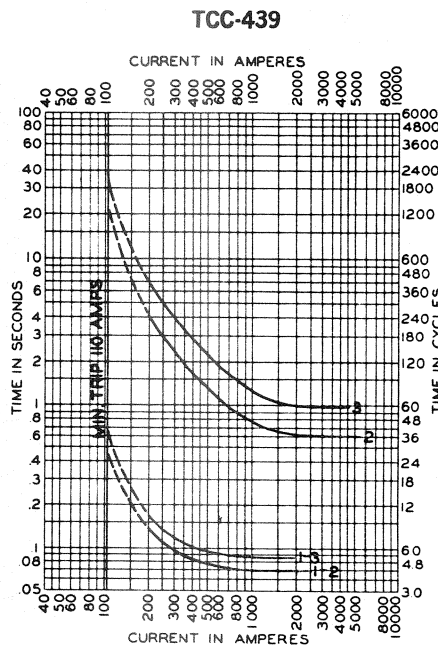

Coil connections are in series. Curves apply to bushing CT ratio of 200:5.

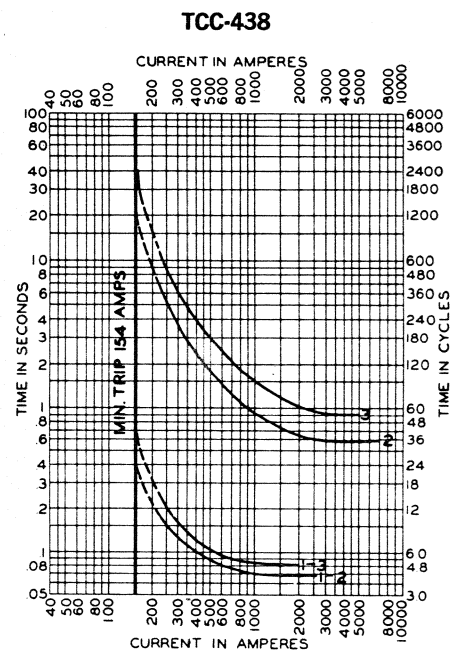

Coil connections are in series. Curves apply to bushing CT ratios of 300:5 and 600:5; they can be indexed to other minimum-trip settings of 205, 247, or 300 amperes.

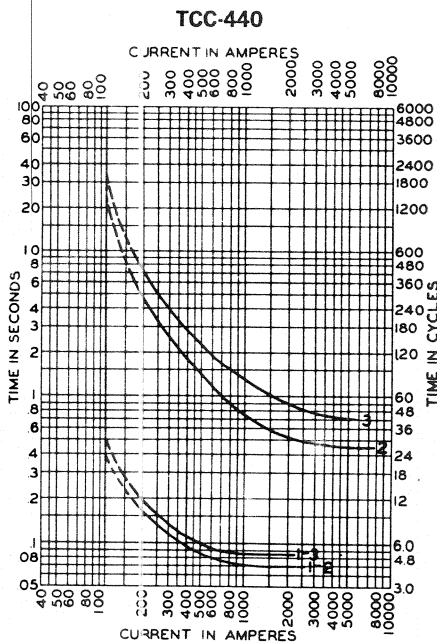

Coil connections are in parallel. Curves apply to all bushing CT ratios; they can be indexed to other minimum-trip settings of 205, 300, 403, 500, or 596 amperes.

\* Add, in order, number of time-delay curve desired; number of fast operations (1, 2, 3, or 4); and the number 1 for series-connected coils or the number 2 for parallel-connected coils. For example, catalog number KA510R321 specifies a standard ground-trip solenoid with time-delay curve 3, two fast operations, and series-connected coils.

### 4. SHUNT-TRIP SOLENOID MECHANISM Types R, RV, W, WV

#### DESCRIPTION

A shunt-trip solenoid mechanism can be used in addition to the normal series overcurrent tripping. Remote relay or manually controlled voltage can be used to actuate the solenoid. After the solenoid is energized, total clearing time of the recloser is a maximum of four cycles.

The shunt-trip solenoid should be energized only momentarily for each operation because the recloser closes normally after being tripped by the shunt-trip solenoid. If this solenoid is energized continuously, the recloser will simply trip and reclose until lockout occurs.

When the shunt-trip mechanism operates, the hydraulic counting mechanism of the recloser functions normally. Therefore, in a recloser set for two fast and two delayed operations, a series-trip opening occurring immediately after two shunt-trip operations will be delayed.

*A shunt-trip solenoid cannot be installed on a recloser equipped with a ground-trip solenoid.*

### ORDERING INFORMATION

When ordering, specify catalog number KA510R\* for standard ground-trip solenoid, and KA419R\* for a modified ground-trip solenoid to obtain this special curve number 1. (TCC-382)



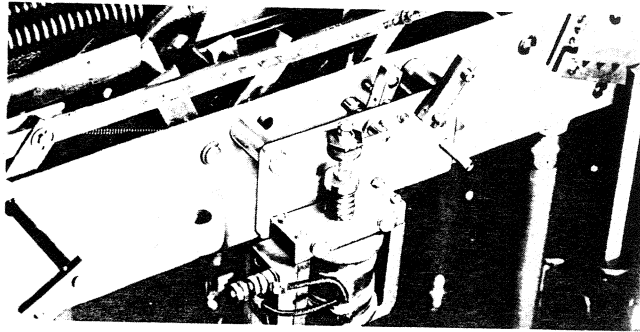

Shunt-trip solenoid mechanism.

### SPECIFICATIONS

Electrical ratings — intermittent duty only

Catalog Number	Rated Voltage, Volts	Operating Range, Volts	Steady-State Current, Amperes
KA378R1	115 ac	95-125	1.3
	24 dc	18-25	1.8
KA378R2	230 ac	190-250	0.65
	48 dc	36-50	1.0
KA378R3	125 dc	90-130	0.6

### ORDERING INFORMATION

When ordering, specify catalog numbers from above table.

## 5. SHUNT-CLOSING SOLENOID MECHANISM Types R, RV, W, WV

### DESCRIPTION

Remote closing can be achieved if an oil circuit recloser is equipped with a shunt-closing solenoid. When energized from a remote source, the shunt-closing solenoid pulls the recloser control lever to the CLOSE position. The control

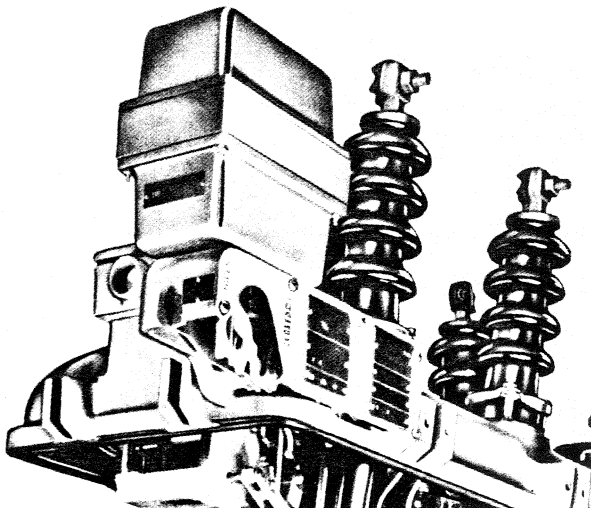

Shunt-closing solenoid mechanism.

lever actuates the recloser closing solenoid contactor; the closing solenoid then operates normally to close the recloser.

Because the shunt-closing accessory is rated for intermittent duty, the remote control should have a normally-open, momentary-contact switch wired in series with the solenoid.

A 7/8-inch diameter opening is provided in the solenoid housing to accommodate 1/2-inch IPS conduit fitting.

Average closing time is about 12 cycles when the recloser is equipped with a d-c closing coil and approximately 9 cycles with a high voltage closing coil.

### SPECIFICATIONS

Electrical ratings of the shunt-closing solenoid mechanism are tabulated below.

Catalog Number	Rated Voltage	Operating Range Volts	Current Requirements, Amperes	
			Inrush	Steady State
KA486R1	115v ac	100-125	32-34	3.25
KA486R2	230v ac	200-250	16-18	1.67
KA486R3	125v dc	90-130	—	6
KA486R4	48v dc	36-50	—	10

### ORDERING INFORMATION

When ordering, specify catalog numbers from the above table.

## 6. DUAL RECLOSING TIME MECHANISM Types R, RV, W, WV

### DESCRIPTION

A 30-cycle reclosing operation, followed by standard 120-cycle reclosures, can be provided by means of the dual reclosing time mechanism. Use of the mechanism does not preclude using all standard reclosures.

### ORDERING INFORMATION

When ordering specify catalog number KA547R for factory installation of the dual reclosing time mechanism.

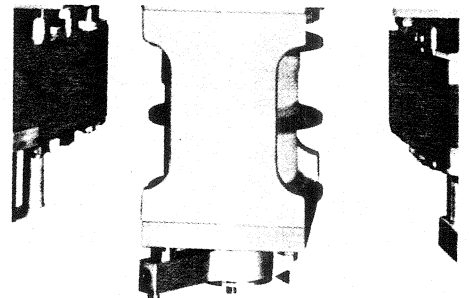

Dual reclosing time mechanism.



### 7. SHUNT-LOCKOUT SOLENOID MECHANISM Types R, RV, W, WV

#### DESCRIPTION

Remote lockout of a recloser can be achieved by means of a shunt-lockout solenoid, which, when energized from an external source, trips the recloser and latches the closing solenoid contactor open. The control lever then drops to OPEN, indicating lock out. Maximum time to lock out contacts after the solenoid is energized is seven cycles. A shunt-lockout solenoid and shunt-closing solenoid are commonly applied on the same recloser to enable remote control of lockout and closing.

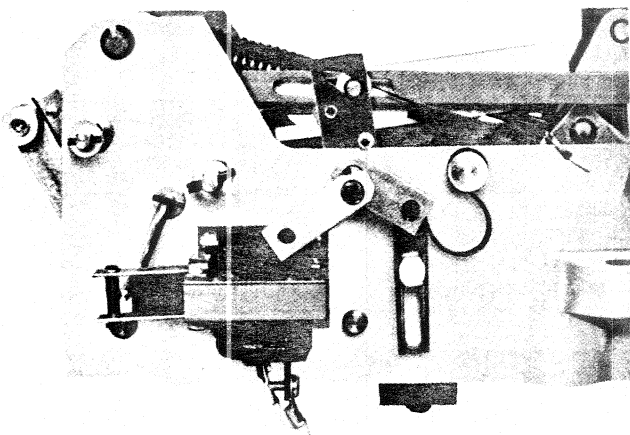

Shunt-lockout solenoid.

To insure the recloser will not be tripped immediately following a normal closing operation, the shunt-lockout solenoid must be de-energized. This can be achieved by wiring the solenoid in series with a momentary contact of a manual control switch. If the solenoid is controlled by a relay, the auxiliary switch accessory should be employed. An 'a' contact of the auxiliary switch should be wired in series with the shunt-lockout solenoid.

#### SPECIFICATIONS

Electrical ratings for the shunt-lockout solenoid are tabulated below.

Catalog Number	Rated Voltage*	Operating Range, Volts	Current Requirements, Amperes
KA475R1	115v ac	95-125	.34
KA475R2	230v ac	190-250	.17
	or		
KA475R3	125v dc**	90-130	.5
	24v dc**	18-50	2.0 at 24v
	48v dc**	18-50	4.0 at 48v

\* Intermittent duty only.

### ORDERING INFORMATION

When ordering, specify catalog number desired from above table. Also include serial number of recloser and add the voltage rating.

### 8. SHUNT-BLOCKING MECHANISM Types R, RV, W, WV

#### DESCRIPTION

A shunt-blocking device enables remote control of reclosing. One type blocks reclosing when the solenoid is energized; the other prevents reclosing when the solenoid is de-energized.

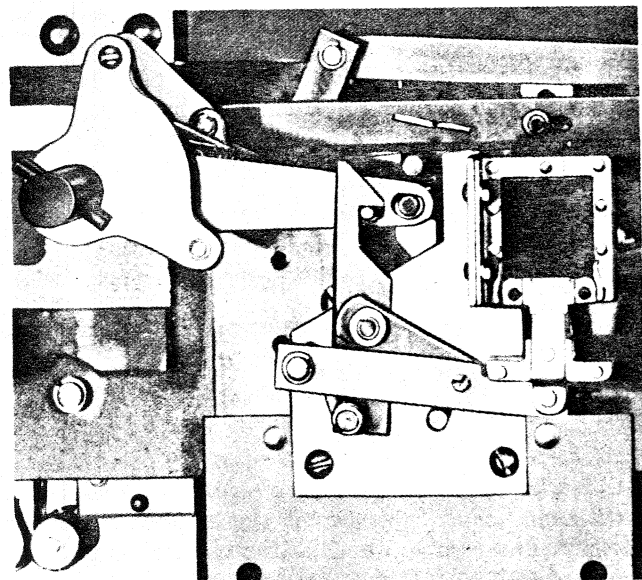

Shunt-blocking mechanism.

#### SPECIFICATIONS

Electrical ratings for the shunt-blocking mechanism are tabulated below.

Catalog Number	Rated AC Voltage	Operating Voltage Range, Volts	Steady-State Current, Amperes
KA275R1	115	95-125	.2 } blocks when
KA275R2	230	190-250	.1 } de-energized
KA276R1	115	95-125	.2 } blocks when
KA276R2	230	190-250	.1 } energized

### ORDERING INFORMATION

When ordering, specify catalog numbers from the above table.

**9. AUXILIARY SWITCH**

Types R, RE, RV, RVE, W, WE, WV, WVE

**DESCRIPTION**

Remote indication of the recloser contact positions or switching of other devices can be achieved if the recloser is equipped with an auxiliary switch. This switch is composed of one, two, or three sections, each of which has two sets of contacts designated 'a' or 'b.' All 'a' contacts are open and 'b' contacts are closed when the recloser is tripped. One set of contacts in each section is usually set for 'a' operation and the other is set of 'b' operation, but other combinations may be ordered. Contacts can be set in the field for either 'a' or 'b' operation.

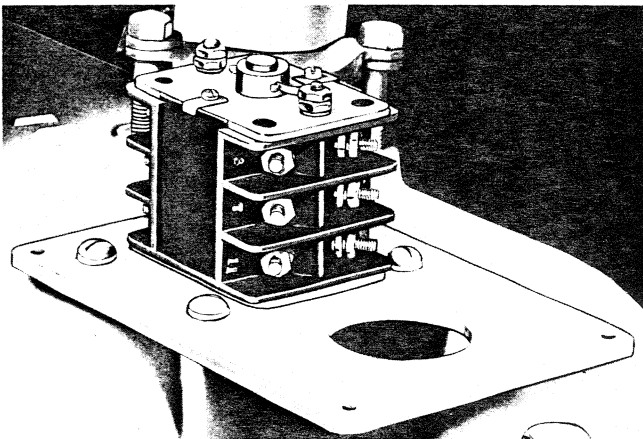

Auxiliary switch (with cover removed).

**RECLOSER AUXILIARY SWITCH**

Interrupting Rating Table — Amperes

Volts	Inductive AC	Noninductive AC	Inductive DC	Noninductive DC
24	—	—	15	20
48	—	—	7.5	10
120	50	80	—	—
125	—	—	1.5	2
240	25	40	—	—
250	—	—	.45	.5

**ORDERING INFORMATION**

When ordering, specify catalog numbers:

**KA369R1** \* 1 stage switch, 2 sets of contacts

**KA369R2** \* 2 stage switch, 4 sets of contacts

**KA369R3** \* 3 stage switch, 6 sets of contacts

\* Specify here number of 'a' contacts desired. When the recloser is open, 'a' contacts are open and 'b' contacts are closed.

**10. LOW VOLTAGE D-C CLOSING COIL**

Types R, RE, RV, RVE, W, WE, WV, WVE

With the substitution of a special d-c closing coil and associated wiring, the recloser will operate from a low voltage d-c source rather than from a normal line-to-line high potential source. Connection of the closing coil to operate from a separate contact source increases the flexibility of the recloser by enabling it to trip and close from either direction with an external control. This is especially desirable where load transfer schemes are employed.

**ORDERING INFORMATION**

A d-c closing solenoid coil and wiring can be specified for factory installation by modifying the recloser catalog number. Merely insert the numeral "7" or "8" in the final or "voltage code number" space of the catalog number. The numeral "7" will provide a 125-volt d-c closing solenoid and "8" will designate a 250-volt d-c closing accessory.

**11. D-C CLOSING WITH AN A-C SOURCE**

Types R, RE, RV, RVE, W, WE, WV, WVE

To operate the d-c closing solenoid accessory from a low voltage a-c source requires factory installation of a modified closing contactor. The contactor is equipped with four silicon diode type rectifiers. Peak inverse voltage of the diodes used for 230-volt operation is 800. 400 P.I.V. diodes are used for a 115 volt a-c source.

Connections to the closing contactor are made to terminals 5 and 6 in the junction box on hydraulic reclosers and to a T-type plug on the recloser cover on electronic units.

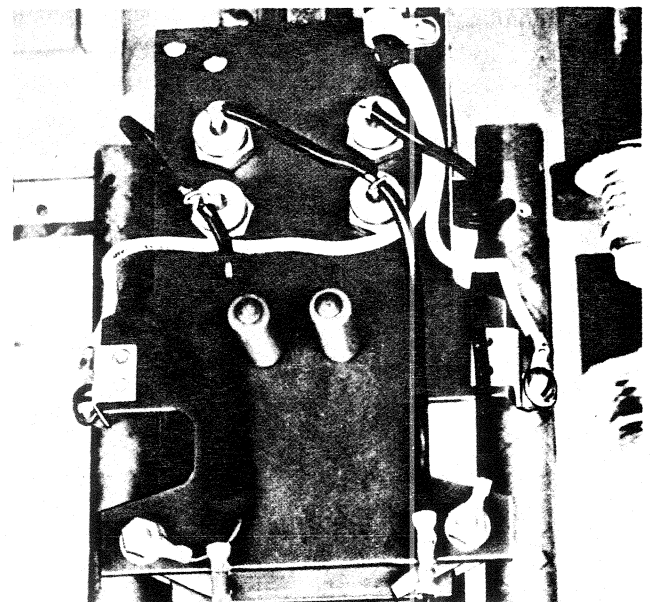

Modified closing contactor.



### ORDERING INFORMATION

For Types R and RV reclosers specify catalog number:  
**KA571R** closing coil contactor factory-mounted for 115-volt a-c source.  
**KA576R** closing coil contactor factory-mounted for 230-volt a-c source.  
 For Types W and WVE reclosers specify catalog number:  
**KA78W** closing coil contactor factory-mounted for 115-volt a-c source.  
**KA80W** closing coil contactor factory-mounted for 230-volt a-c source.

For Types RE, RVE reclosers specify catalog number:  
**KA51RE** closing coil contactor factory-mounted for 115-volt a-c source. Use No. 7 closing solenoid coil.  
**KA57RE** closing coil contactor factory-mounted for 230-volt a-c source. Use No. 8 closing solenoid coil.

For Types WE, WVE reclosers specify catalog number:  
**KA8WE** closing coil contactor factory-mounted for 115-volt a-c source. Use No. 7 closing solenoid coil.  
**KA10WE** closing coil contactor factory-mounted for 230-volt a-c source. Use No. 8 closing solenoid coil.

### 12. STUD-TYPE TERMINALS

Types R, RE, RV, RVE, W, WE, WV, WVE

#### DESCRIPTION

Connection of tubular bus, braided straps, or special conductor devices to the recloser terminals is simplified by the use of stud-type terminals. These terminal studs can be furnished in place of the universal bolted terminals normally supplied.

Terminal studs are silver plated to insure good electrical contact. A disposable covering protects threads prior to installation. Connectors for adapting the terminal studs to accommodate phase conductors can also be furnished. These connectors fit the 1/8 inch-12USA threads of the terminal studs.

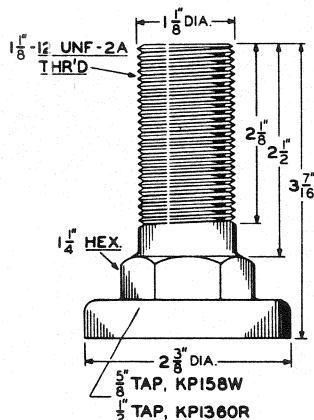

### ORDERING INFORMATION

When ordering, specify catalog numbers:  
**KA800W** for six factory-installed terminals on Types W, WE, WV, WVE reclosers.  
**KA842R** for six factory-installed terminals on Types R, RE, RV, RVE reclosers.  
**KP1360R2** for one terminal for field installation on Types W, WE, WV, WVE, reclosers\*.  
**KP1360R1** for one terminal for field installation on Types R, RE, RV, RVE reclosers\*.  
 \* One KP120L bushing terminal gasket should be ordered with each terminal.

### 13. FLAT PAD TERMINALS

Types R, RE, RV, RVE, W, WE, WV, WVE

To provide for bolted bus connections in substations or attachment to leads with terminal lugs, two-hole flat pad terminals can be factory-installed on the recloser bushings in place of the standard universal clamp-type terminals or the optional stud-type terminals. The special flat pad terminals are of a special red brass alloy with good current carrying characteristics and are tin-plated to resist corrosion.

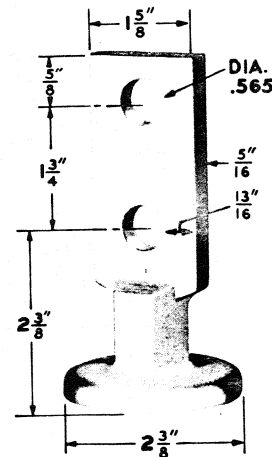

Flat pad terminal.

### ORDERING INFORMATION

When ordering, specify catalog number:  
**KA579R** factory installation of two-bolt flat pad terminals for Types R, RE, RV and RVE.  
**KA82W** factory installation of two-bolt flat pad terminals for Types W, WE, WV and WVE.



**14. CREEPAGE DISTANCE BUSHINGS**

**Types R, RE, RV, RVE, W, WE, WV, WVE**

Special extra creepage distance bushings are available for these reclosers. These bushings are for application in atmospheres which reduce the effectiveness of porcelain insulation due to salt spray, smog, and smoke. Although easy to install in the field, they may be ordered initially with the recloser and installed at the factory.

Standard bushing creepage distance for these 14.4 kv reclosers is 11 5/8 inches, and 17 inches for the 24.9 kv reclosers.

**ORDERING INFORMATION**

When ordering for Types R and RE only, specify catalog number:

**KA562R** for six factory-installed 17-inch creepage distance bushings.

When ordering for Types W and WE only, specify catalog number:

**KA25W** for six factory-installed 17-inch creepage distance bushings.

When ordering for a Type RE or RVE, specify catalog number:

**KA20RV** for factory installation of six 26 1/2-inch creepage distance oil-filled type bushings.

When ordering for a Type WV or WVE, specify catalog number:

**KA13WV** for factory installation of six 26 1/2-inch creepage distance condenser type bushings.

**15. JUNCTION BOX AND TERMINAL BLOCK**

**Types R, RV, W, WV**

Connection between internally mounted accessories and remote control devices are simplified by the use of the junction box and terminal board. Seven numbered terminals provide a convenient connection point for ground-trip, shunt-trip, shunt-lockout, shunt-blocking, and d-c closing solenoids. Terminals are sealed to prevent moisture from entering the recloser.

Three one-inch IPS threaded hubs are provided for conduit or cable fittings.

**ORDERING INFORMATION**

When ordering, specify catalog number **KA187R** for a junction box and terminal block.

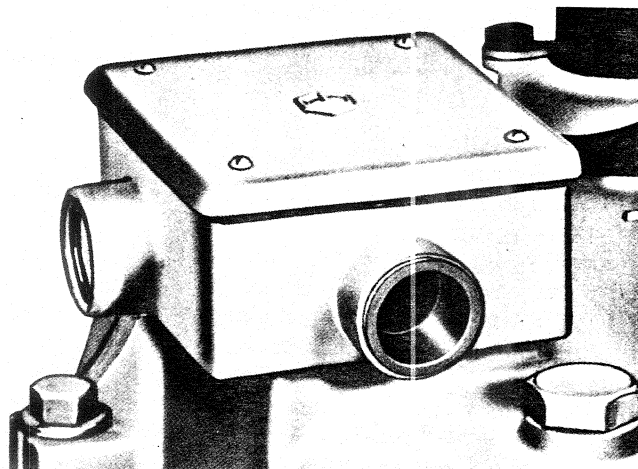

Junction box.

**16. EMERGENCY MANUAL CLOSING TOOL**  
**Types R, RE, RV, RVE, W, WE, WV, WVE**

Emergency manual closing of these reclosers is possible with the KA476R insulated closing tool with matching shaft and hood assembly. Manual closing may be required when current is to be back-fed through the recloser, when a closing-solenoid fuse is blown, or for testing purposes. The shaft and hood assembly mounted on the recloser's head casting is mechanically linked with the main reclosing shaft. OPEN and CLOSED contact positions are indicated.

**CAUTION:** Not to be used to close in on energized line!

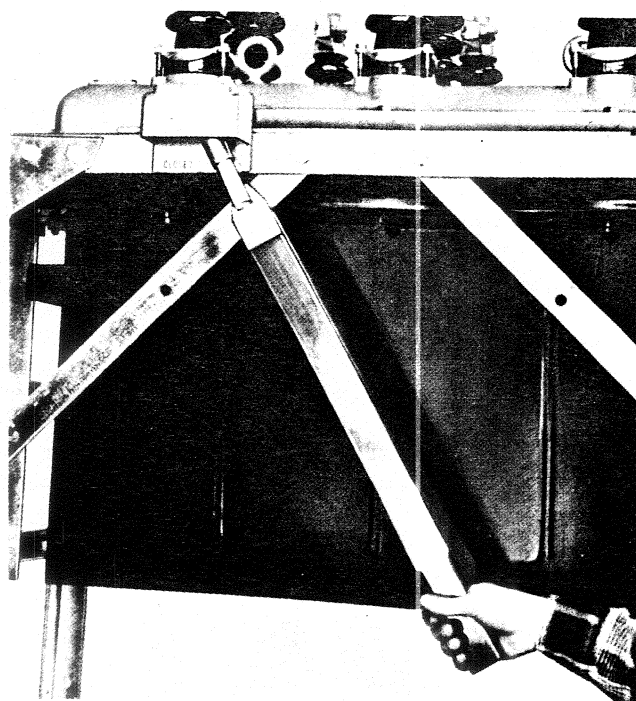

Closing tool.



## ORDERING INFORMATION

Specify catalog number KA476R for an emergency manual closing tool kit for field installation.

### 17. MOUNTING FRAMES

Types R, RE, RV, RVE, W, WE, WV, WVE

Installation can be simplified by the use of substation or pole mounting frames designed specifically for the reclosers. A KA137R frame facilitates mounting of a Type R or RE recloser on a single pole. A KA136R frame performs the same function as the KA137R frame, except provision is made for mounting a TR current transformer. Use of a KA-662R portable windlass in conjunction with either frame simplifies lowering the recloser tank for inspection and maintenance. However, the portable windlass lowers the recloser tank only and should not be used for lifting the recloser. These frames are not recommended for mounting a Type RV, RVE, W, WE, WV, or WVE recloser.

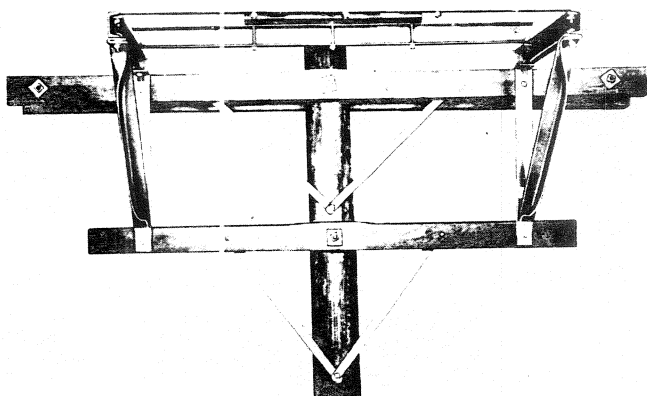

Crossarm mounting frame for Types R and RE reclosers.  
(KA137R)

When the recloser interrupts heavy fault currents, this adjustable frame has ample strength to absorb any shocks generated. Brackets can be attached to the frame to mount current metering accessories. A removable windlass can be provided to lift the recloser and current transformer, or to lower the tanks for inspection and maintenance. So that one windlass can be purchased for use on several frames in the same substation, the windlass is specified separately. When mounted in the KA584R1 frame, the recloser bushing terminals range from 97½ to 112½ inches above the foundation.

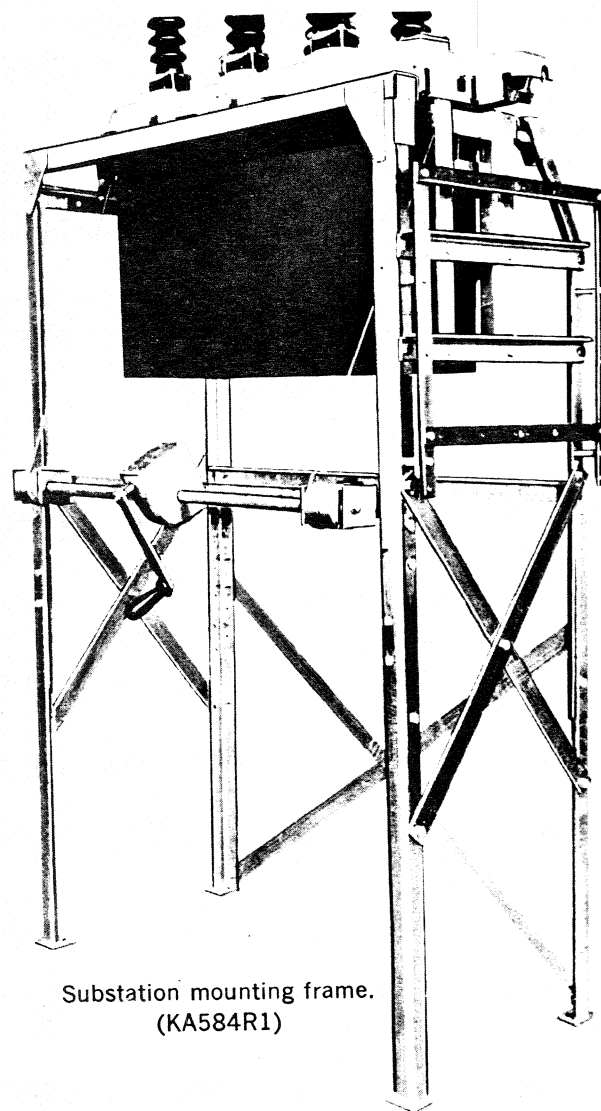

Substation mounting frame.  
(KA584R1)

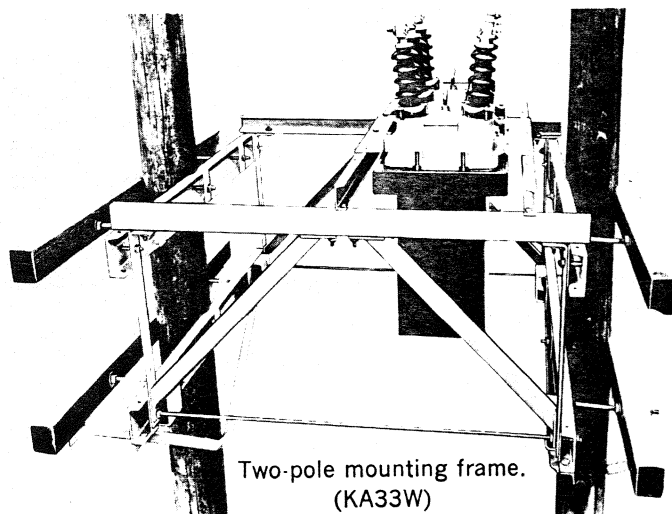

Two-pole mounting frame.  
(KA33W)

This frame provides a convenient means of mounting a recloser between two poles. The two-pole arrangement has

the rigidity necessary to support the recloser when severe fault currents are interrupted. Also available is the KA662R windlass for use with this frame to lower the tank for maintenance or inspection. A Type TR transformer can also be mounted in the KA33W frame with the recloser.

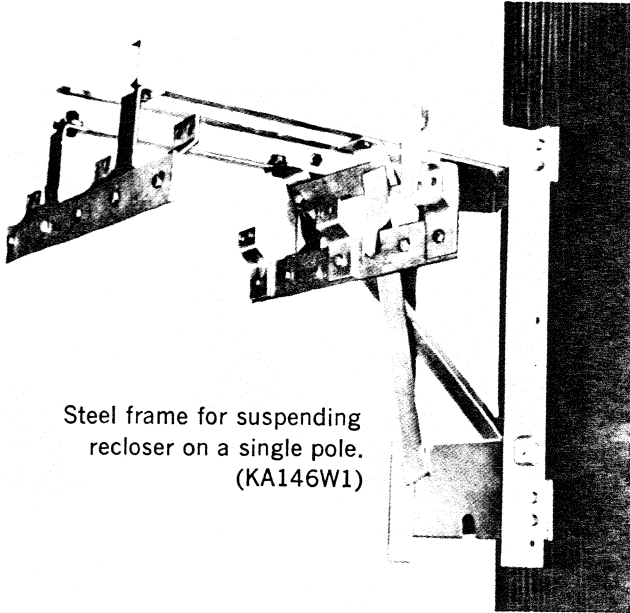

Steel frame for suspending recloser on a single pole. (KA146W1)

When two-pole mounting of recloser is not feasible, the KA146W1 frame can be employed to provide sturdy support on one pole. The KA146W2 windlass can be employed with this frame to raise or lower the recloser tank. However, the windlass is not intended for lifting the entire recloser.

**NOTE:** When ordering BCT's on recloser to be mounted in KA146W1 single pole mounting frame, specify KA880R (source side BCT's) or KA883R (load side BCT's).

### ORDERING INFORMATION

When ordering, specify catalog numbers:

- a. **KA137R** for a pole-mounting frame for a Type R recloser.
- b. **KA136R** for a pole-mounting frame for a Type R recloser and TR current transformer.
- c. **KA584R1** for a substation mounting frame.
- d. **KA584R2** for a removable tank lifting windlass used on the KA584R1 frame.
- e. **KA584R4** for brackets to mount metering accessories on the end of the KA584R1 frame.
- f. **KA584R3** for brackets to mount Type TR current transformer on KA584R1 frame.
- g. **KA172R** for two mounting angles to attach to recloser head castings; used in custom-built mounting frames.

- h. **KA146W1** for a single-pole mounting suspension hanger.
- i. **KA33W** for a two-pole mounting frame.
- j. **KA584R6** bracket and hardware for mounting ground trip shorting switch on a KA584R1 frame.
- k. **KA146W2** windlass for KA146W1 suspension hanger.
- l. **KA662R** windlass for KA33W, KA137R, KA136R frames.

### 18. TANK VALVE

Types R, RE, RV, RVE, W, WE, WV, WVE

A 1/2-inch gate valve simplifies oil sampling or draining. The standard recloser is equipped with a solid brass plug.

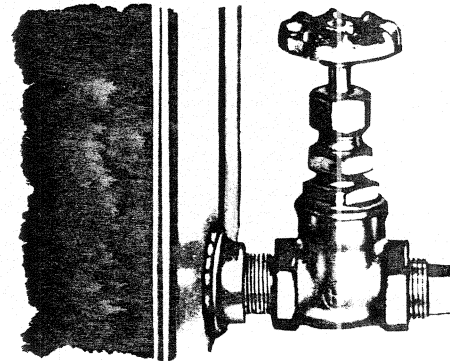

### ORDERING INFORMATION

When ordering, specify catalog number KA809R for a tank valve.

### 19. CURRENT METERING

Types R, RE, RV, RVE, W, WE, WV, WVE

Useful in load balance studies, current metering can be installed on a recloser substation mounting frame and connected to bushing-type current transformers or a Type TR current transformer.

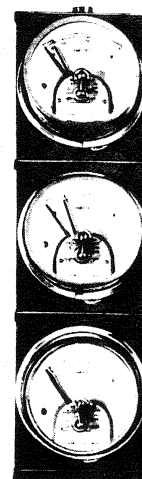

Trough-mounted ammeters. (KA801TR and KA802TR)



In the KA801TR and KA802TR assemblies, three thermal ampere-demand meters are mounted in a rain-tight trough that can be attached to the recloser mounting frame. Meters are available with or without instantaneous indicators in addition to the average indicators. Maximum indicators are furnished on thermal meters.

Three 3½-inch indicating ammeters are panel mounted in a weather-proof enclosure in the KA19TR assembly.

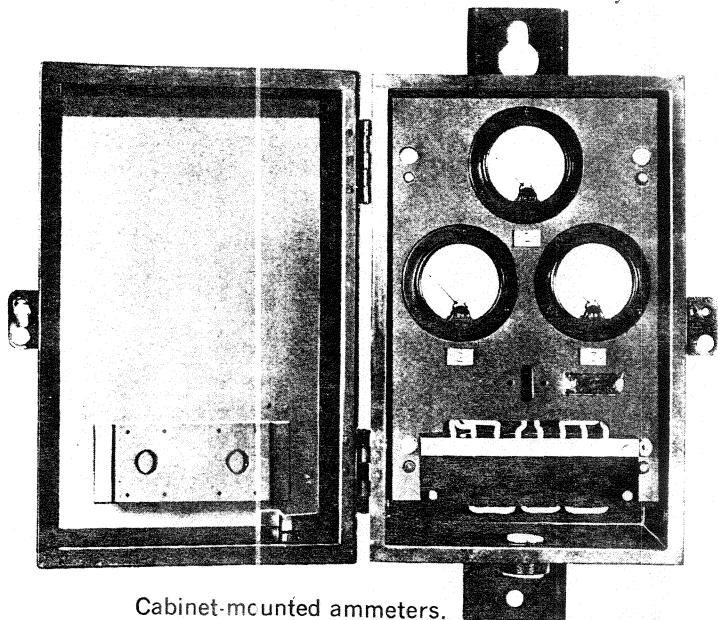

Cabinet-mounted ammeters.  
(KA19TR)

## ORDERING INFORMATION

When ordering, specify catalog numbers:

**KA19TR \* M †** for three, 3½-inch round indicating ammeters mounted in a weather-proof cabinet.

**KA801TR \* M †** for three Sangamo "Lincoln" Type ADS thermal ampere-demand meters with maximum demand indicators. Socket-type meters are mounted in a vertical meter trough equipped with circuit-closing socket jaws.

**KA802TR \* M †** for same as in KA801TR assembly, except meters also have 2½-inch instantaneous indicating elements.

\* Add meter full-scale calibration. (5, 6, 10, 100, 200, 300, 400, 600 . . .).

† Add rating of meter movement in amperes. (3, 5, 6, 10, 15 . . .)‡.

‡ Standard ratings of Sangamo thermal ampere-demand meter movements are 3, 5, and 6 amperes. Other ratings can be furnished, but delivery may be delayed.

## 20. LOCKOUT-INDICATING SWITCH Types R, RV, W, WV

### DESCRIPTION

A lockout-indicating switch assembly can be added to these

reclosers for remote indication that the recloser has locked out. The switch is particularly useful in load-transfer schemes.

Consisting of two single-pole, double-throw switches in a weatherproof housing, this assembly is actuated by the recloser manual operating lever. A threaded opening for one-half inch IPS conduit or cable grip is provided.

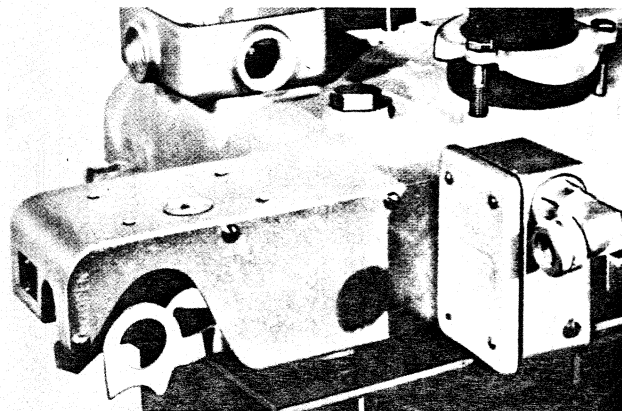

Lockout-indicating switch.

### SPECIFICATIONS

Continuous current rating is 10 amperes; inrush current rating is 15 amperes.

Interrupting Ratings, Amperes	Operating Voltage
10	120v ac
5	240v ac
0.5	125v dc
0.25	250v dc

## ORDERING INFORMATION

When ordering, specify catalog number KA269R for lockout-indicating switch.

## 21. REMOTE OPERATING MECHANISM Types R, RV, W, WV

An effective time and climb saver that permits remote manual operation of pole mounted reclosers is available with factory or field installation of a mechanical remote operating mechanism. The mechanism includes a slide connection to the recloser, operating linkage at the top of the pole, a flexible push-pull type control cable and an operating handle assembly at a convenient operating height. In operation the handle is pushed up to close and pulled down to open. In an intermediate position the handle will be in Neutral. After the handle has been pushed up close it should be returned to Neutral so that the recloser is free to trip and reclose when a fault occurs.

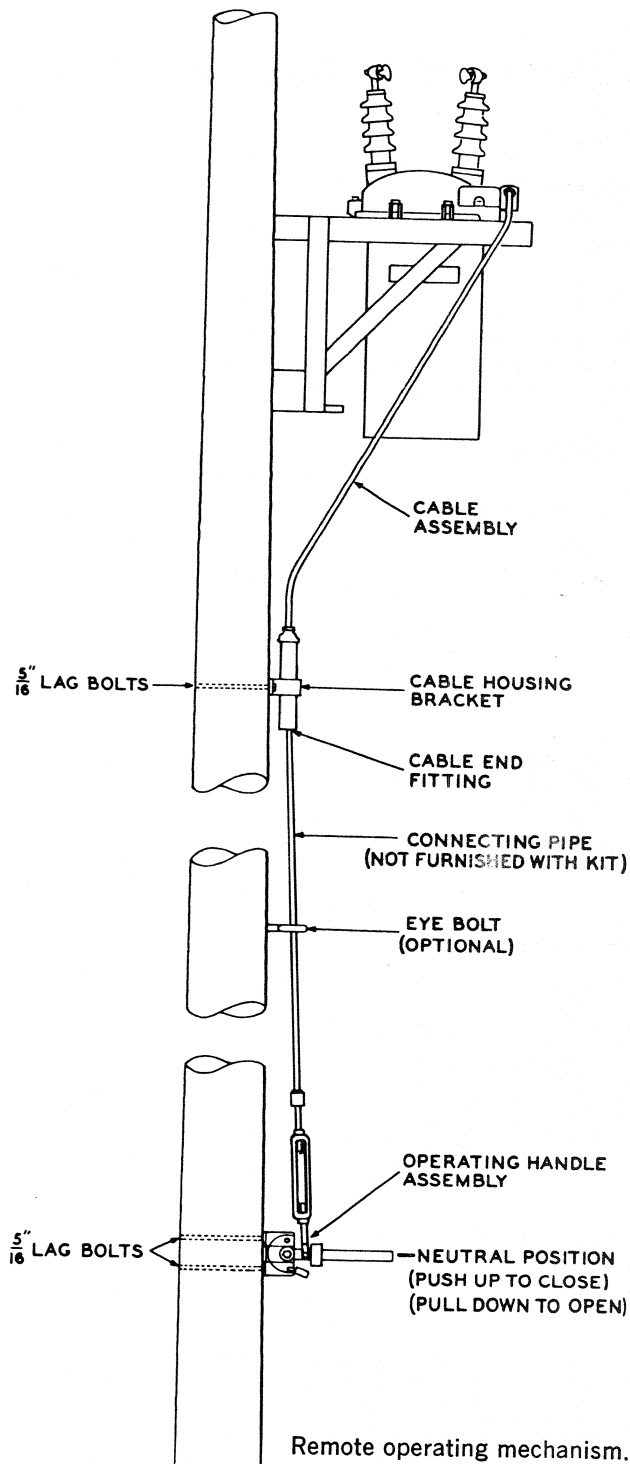

**ORDERING INFORMATION**

Specify catalog number KA653R for a remote operating mechanism.

**22. GROUND-TRIP SHORTING SWITCH**  
Types R, RV, W, WV

An external switch can be provided to enable blocking the ground-trip solenoid. This switch can be useful when the recloser is being bypassed or when loads are momentarily unbalanced. If current metering is employed in addition to ground-tripping, the solenoid shorting switch can be wired to disable the ground-trip solenoid but not the current metering.

**ORDERING INFORMATION**

When ordering specify catalog number KA813R1 for a ground-trip solenoid shorting switch or KA813R2 for a shorting switch to be bracket-mounted on the recloser and cable connected to the recloser junction box.

**23. OIL LEVEL SIGHT GAUGE, BULL'S-EYE TYPE**  
Types R, RE, RV, RVE, W, WE, WV, WVE

A direct sighting oil gauge can be factory-installed in the tank of the recloser. The gauge is equipped with a white reflector background that permits for easy visibility of the oil level and also aids in viewing the condition of the oil.

**ORDERING INFORMATION**

Specify catalog number KA123W for an oil level sight gauge.

**24. SHIPMENT OF RECLOSER AND ACCESSORY EQUIPMENT MOUNTED AND WIRED IN SUBSTATION FRAME KA584R1**

Accessories for field installation are ordered as shown in the preceding paragraphs. The option of factory assembly, wiring, and mounting of control cabinets, current transformers, ground-trip shorting switch, ground-trip solenoid mechanism, and metering equipment can be ordered by specifying catalog numbers as follows: (order mounting brackets separately)

Description	Catalog Number
RE, RVE, WE, WVE Recloser and ME control on frame. No accessories . . . . .	KA800WE
Recloser and ME control with load side BCT's wired to KA801TR or KA802TR meters . . . . .	KA801WE1
Recloser and ME control with source side BCT's wired to KA801TR or KA802TR meters . . . . .	KA802WE1



Description	Catalog Number
<b>R, RV, W, WV</b>	
Recloser on frame. No accessories . . . . .	KA813W
Recloser with load side BCT's wired to KA19TR meters and ground trip solenoid, with or without shorting switch . . . . .	KA817W1
Reclosers with load side BCT's wired to KA801TR or KA802TR meters and ground trip solenoid, with or without shorting switch . . . . .	KA817W2
Recloser with source side BCT's wired to KA19TR meters and ground trip solenoid, with or without shorting switch . . . . .	KA818W1
Recloser with source side BCT's wired to KA801TR or KA802TR meters and ground trip solenoid, with or without shorting switch . . . . .	KA818W2
Recloser with load side BCT's wired to KA19TR meters. No ground trip solenoid	KA820W1
Recloser with load side BCT's wired to KA801TR or KA802TR meters. No ground trip solenoid . . . . .	KA820W2
Recloser with source side BCT's wired to KA19TR meters. No ground trip solenoid	KA821W1
Recloser with source side BCT's wired to KA801TR or KA802TR meters. No ground trip solenoid . . . . .	KA821W2
Recloser with load side BCT's wired to ground trip solenoid and shorting switch. No meters . . . . .	KA850R1
Recloser with source side BCT's wired to ground trip solenoid and shorting switch. No meters . . . . .	KA850R2
<b>UNITS WITH TR CURRENT TRANSFORMERS</b>	
<b>R, W</b>	
Recloser and TR transformer on frame. No accessories . . . . .	KA814W
Recloser and TR transformer wired to KA19TR meters and ground trip solenoid, with or without shorting switch . . . . .	KA815W
Recloser and TR transformer wired to KA801TR or KA802TR meters and ground trip solenoid, with or without shorting switch . . . . .	KA816W
Recloser and TR transformer wired to ground trip solenoid, with or without shorting switch. No meters . . . . .	KA825W
Recloser and TR transformer wired to KA801TR or KA802TR meters. No ground trip solenoid . . . . .	KA826W

**MISCELLANEOUS FACTORY ASSEMBLIES**

Description	Catalog Number
R, RV, W, or WV recloser with load side BCT's wired to ground trip solenoid. Can be ordered with any mounting frame except KA146W single-pole frame . . . . .	KA843R1
R, RV, W, or WV recloser with source side BCT's wired to ground trip solenoid. Can be ordered with any mounting frame except KA146W1 single-pole frame.	KA843R2
Conduit installed from KA187R junction to KA486R shunt closing. Can be ordered with any mounting frame. Cannot be used when load side BCT's are wired to ground trip solenoid . . . . .	KA882R

**25. CONDUIT AND WIRING KITS FOR FIELD INSTALLATION**

All kits include conduit and wire necessary to connect recloser and accessories specified. All kits shipped disassembled. Unless otherwise indicated, all kits are to be used on substation mounting frame KA584R1.

Description	Catalog Number
<b>RE, RVE, WE, WVE</b>	
For wiring load side BCT's to KA801TR or KA802TR meters . . . . .	KA801WE2
For wiring source side BCT's to KA801TR or KA802TR meters . . . . .	KA802WE2
<b>R, RV, W, WV</b>	
For wiring load side BCT's to KA19TR meters and ground trip solenoid, with or without shorting switch . . . . .	KA819W1
For wiring load side BCT's to KA801TR or KA802TR meters and ground trip solenoid with or without shorting switch . . . . .	KA819W2
For wiring load side BCT's to KA19TR, KA801TR, or KA802TR meters. No ground trip solenoid . . . . .	KA820W3
For wiring source side BCT's to KA19TR meters and ground trip solenoid, with or without shorting switch . . . . .	KA824W1
For wiring source side BCT's to KA801TR or KA802TR meters and ground trip solenoid, with or without shorting switch . . . . .	KA824W2



**KITS FOR KA146W1 SINGLE POLE MOUNTING FRAME**

Description	Catalog Number
For wiring source side BCT's to ground trip solenoid, without shorting switch. Use with R, RV, W, or WV recloser . . . . .	<b>KA880R1</b>
For wiring source or load side BCT's, no ground trip solenoid. Use with R, RV, or WV recloser . . . . .	<b>KA880R2</b>
For wiring load side BCT's to ground trip solenoid, without shorting switch. Use with R, RV, W, or WV recloser.	<b>KA883R</b>

**Catalog Number**

Set of three 2000:5 amperes, multi-ratio on bushings 2, 4, 6 (10L200) . . . . . **KA127CE4**  
 Set of six 600:5 amperes, multi-ratio, one on each bushing (10L100) . . . . . **KA127CE5**

**3. Tank Valves**

Optional one-inch gate valves simplify oil sampling or draining. Order as Tank Valves KA101CE. (Set of 3).

**4. Visual Oil Gauge**

Set of three bull's-eye type gauges. Order KA8CE Visual Oil Gauges.

**26. KITS FOR USE WITH TR TRANSFORMERS AND TYPES R AND W RECLOSERS**

Description	Catalog Number
For wiring TR transformer to ground trip solenoid . . . . .	<b>KA810R</b>
For wiring TR transformer to ground trip solenoid and shorting switch. No meters	<b>KA811W</b>
For wiring TR transformer to KA810TR or KA802TR meters and ground trip solenoid, with or without shorting switch . . . . .	<b>KA812W1</b>
For wiring TR transformer to KA19TR meters and ground trip solenoid with or without shorting switch.	<b>KA812W2</b>

**5. Metering Accessory Kit**

Factory assembly of vertical meter trough on operator cabinet; includes connecting cable and terminal block . . . . . **KA147CE**

**TYPES CXE, CVE ACCESSORIES**

For control accessories refer to Section 280-65. Mounting frames are listed in Section 280-35.

**1. Cabinet Heater**

Includes two heater elements for application of these reclosers in humid atmospheres. Will reduce condensation on motor, trip solenoid and wiring. For a 115-volt a-c heater with two 250 ohm resistors order as Cabinet Heater KA-100CE1. For 230-volt a-c heater with two 1000-ohm resistors order as KA100CE2. The resistors are paralleled to provide 105-watt heating rate.

**RECLOSER ACCESSORIES**

**2. Bushing Current Transformers (factory-installed)**

	Catalog Number
Set of three 600:5 amperes, multi-ratio on bushings 1, 3, 5 (10L100) . . . . .	<b>KA127CE1</b>
Set of three 600:5 amperes, single-ratio on bushings 2, 4, 6 (.3B-0.5, .6B-1.0, 1.2B-2.0) . . . . .	<b>KA127CE2</b>
Set of three 1200:5 amperes, multi-ratio on bushings 2, 4, 6 (10L200) . . . . .	<b>KA127CE3</b>

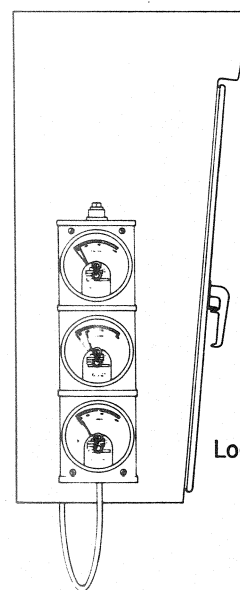

Location of meters on operator cabinet. Types CXE, CVE; per KA147CE.

**TYPE VSA ACCESSORIES**

Accessories for the recloser and the control are listed and ordered separately. For control accessories refer to Section 280-65. The Type VSA recloser will operate only with a Form 3 Type ME control, and only with Form 3 control accessories, (Form 3 controls have serial numbers ME-4000 and above). When ordering Type VSA recloser accessories, select and specify each in accordance with your requirements. Mounting frames are listed in Section 280-35.

**1. Bushing Current Transformers (factory-installed)**

	Catalog Number
Set of three 600:5 amperes, multi-ratio, bushings 1, 3, 5 (10L100) . . . . .	<b>KA51VS1</b>



	Catalog Number
Set of three 600:5 amperes, single-ratio, bushings 1, 3, 5 (.3B-0.5, .6B-1.0, 1.2B-2.0) . . . . .	KA51VS2
Set of three 600:5 amperes, multi-ratio, bushings 1, 3, 5 and a set of three 600:5 amp, single ratio, bushings 2, 4, 6 . . . . .	KA51VS3
Set of three 1200:5 amperes, multi-ratio, bushings 1, 3, 5 (10L200) . . . . .	KA51VS4
Set of three 1200:5 amperes, single-ratio, bushings 1, 3, 5 (.3B-4.0, .6B-8.0) . . . . .	KA51VS5
Set of three 1200:5 amperes, multi-ratio, bushings 1, 3, 5, and a set of three 1200:5 amp, single-ratio, bushings 2, 4, 6 . . . . .	KA51VS6

**2. Auxiliary Switch (factory-installed)**  
(See page 9 for interrupting ratings)

One stage, 2 contacts with terminal block . . . . .	KA54VS1
Two stage, 4 contacts with terminal block . . . . .	KA54VS2
Three stage, 6 contacts with terminal block . . . . .	KA54VS3

**3. Metering Accessory Kits (field-installed)**

Kit for mounting of meter trough, right front, includes short cable, bracket, hardware, and fittings . . . . .	KA58VS1
Kit for mounting of meter trough, left rear, includes long cable, bracket, hardware, and fittings . . . . .	KA58VS2
Set of three thermal ampere-demand meters with maximum demand indicators mounted in a vertical meter trough . . . . .	KA801TR * M †
Set of three above meters in trough with 2½-inch instantaneous indicating elements . . . . .	KA802TR * M †

\* Add meter full-scale calibration (5, 6, 10, 100, 200, 300, 400, 600 . . .)

† Add rating of meter movement in amperes (3, 5, 6 . . .)

**TYPES ME, MLE, MVE ACCESSORIES**

For control accessories refer to Section 280-65. Mounting frames are listed in Section 280-35.

**1. Cabinet Heater**

50-watt heater for application of these reclosers is available for humid atmospheres. They will reduce condensation on motor, trip solenoid and wiring. Ratings are 250 and 500 ohms for 115- and 230-volt heaters, respectively. For 115-volt service order Cabinet Heater KA1072M1. For operation with a 230-volt system order Cabinet Heater KA1072-M2.

**2. Bushing Current Transformers**

(factory-installed on bushing numbers as designated)

**Types MLE, MVE Reclosers**

	Catalog Number
Set of three 600:5 amperes, multi-ratio (1, 3, 5) and three 600:5 amperes, single-ratio (2, 4, 6) . . . . .	KA950M1
Set of six 600:5 amperes, multi-ratio (one on each bushing) (10L100) . . . . .	KA951M1
Set of three 600:5 amperes, multi-ratio (1, 3, 5) (10L100) . . . . .	KA952M1
(Set of six 600:5 amperes, single-ratio (one on each bushing) . . . . .	KA953M1
Set of three 600:5 amperes, single ratio (1, 3, 5) (.3B-0.5, .6B-1.0, 1.2B-2.0) . . . . .	KA954M1

**Type ME Recloser**

Set of three 1200:5 amperes, multi-ratio (1, 3, 5) and three 1200:5 amperes single-ratio (2, 4, 6) . . . . .	KA955M1
Set of six 1200:5 amperes, multi-ratio (one on each bushing) (10L200) . . . . .	KA956M1
Set of three 1200:5 amperes, multi-ratio (1, 3, 5) (10L200) . . . . .	KA957M1
Set of six 1200:5 amperes, single-ratio (one on each bushing) (.3B-4.0, .6B-8.0) . . . . .	KA958M1
Set of three 1200:5 amperes, single-ratio (1, 3, 5) (.3B-4.0, .6B-8.0) . . . . .	KA959M1

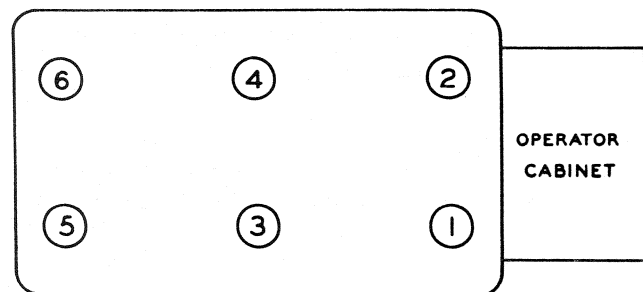

Bushing designation for installation of bushing current transformers on Types CXE, CVE, ME, MLE, MVE and VSA.

**3. Current Metering**

Current metering can be installed on the recloser frame and connected to the bushing type current transformers. Three thermal ampere-demand meters, mounted in a rain-tight trough, are available with or without instantaneous indicators. To order either, specify KA801TR or KA802TR per page 14.



When either of these meters are ordered, factory assembly to the recloser frame with necessary cable and wiring can be provided by ordering: KA995M, factory meter mounting accessory.

#### 4. Oil Level Sight Gauge

An oil level sight gauge, bull's eye type, with a white reflective background to indicate oil condition and level can be factory installed on the recloser tank. To order specify oil level sight gauge KA1089M.

#### 5. Tank Valve

An optional ½-inch gate valve can be substituted for the recloser tank drain plug to simplify sampling and draining. To order, specify KA809R tank valve.